

Heizspannung	U_f	6,3	V
Heizstrom	I_f	230	mA

Allgemeine Werte:

Triode, statisch

Anodenspannung	U_a	100	V
Anodenstrom	I_a	10	mA
Steilheit ($U_{gTg3} = 0$ V)	S	2,8	mA/V
Verstärkungsfaktor	μ	22	

Hexode

Anodenspannung	U_a	250	V
Schirmgitterspannung	U_{g2g4}	85	V
Oszillatorspannung ($I_{g3} \times R_{g3}$)	U_{osc}	7,7	V
Gitterableitwiderstand	R_{gTg3}	22	k Ω
Regelbereich		1 : 100	
Gittervorspannung	U_{g1}	-2 -21	V
Anodenstrom	I_a	3 —	mA
Schirmgitterstrom	I_{g2+g4}	3 —	mA
Mischsteilheit	S_c	750 7,5	μ A/V
Innerer Widerstand	R_i	> 1 —	M Ω

Betriebswerte:

Triode, dynamisch

Betriebsspannung	U_a	250	250	V
Anodenwiderstand	R_a	33	33	k Ω
Gitterableitwiderstand	R_{gTg3}	22	47	k Ω

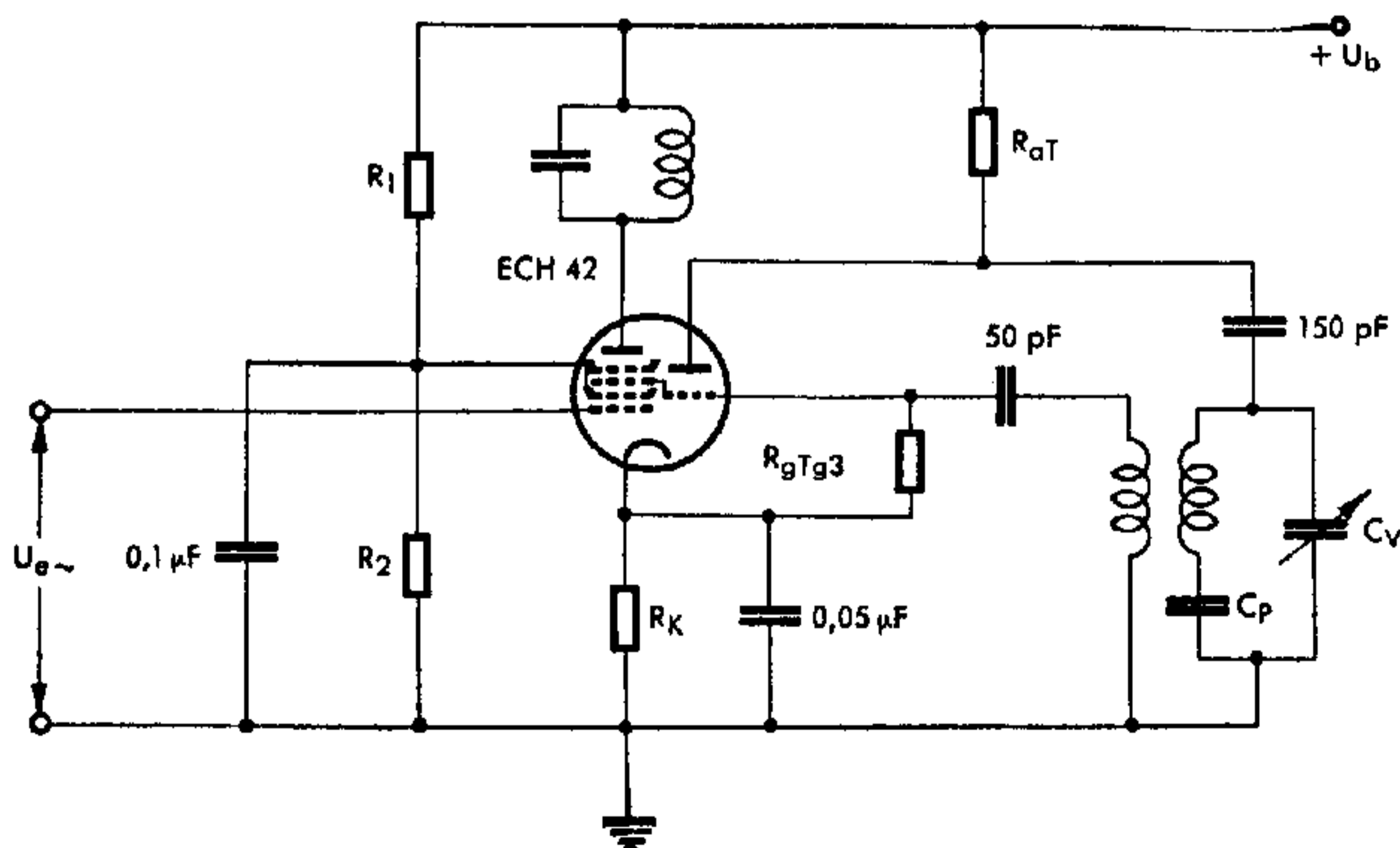

Gitterstrom	I_g	350	200	μA
Anodenstrom	I_a	5,1	4,8	mA
Oszillatorspannung	U_{osc}	8,0	8,0	V_{eff}
Effektivsteilheit	S_{eff}	0,6	0,55	mA/V

Hexode

Betriebsspannung	U_b	250	V	
Spannungsteiler für Schirmgitterspannung	$R_1 = R_2$	27	k Ω	
Kathodenwiderstand	R_k	180	Ω	
Oszillator-Gitterableitwiderstand	R_{gTg3}^*	22	k Ω	
Gitterstrom	$I_{gT+g3}^*)$	350	μA	
Regelbereich		1 : 100		
Gittervorspannung	U_{g1}	-2	-29	V
Schirmgitterspannung	U_{g2g4}	85	124	V
Anodenstrom	I_a	3	—	mA
Schirmgitterstrom	I_{g2+g4}	3	—	mA
Mischsteilheit	S_c	750	7,5	$\mu A/V$
Innerer Widerstand	R_i	> 1	> 5	M Ω
Äquivalenter Rauschwiderstand	r_{aeq}	75	—	k Ω
Elektronischer Eingangswiderstand bei $f = 100$ MHz	r_e	1,8	—	k Ω

*) Wenn $R_{gTg3} = 47$ k Ω gewählt wird, muß I_{gT+g3} auf 200 μA eingestellt werden.

Hexode bei gemeinsamem Spannungsteiler mit einer EAF 42

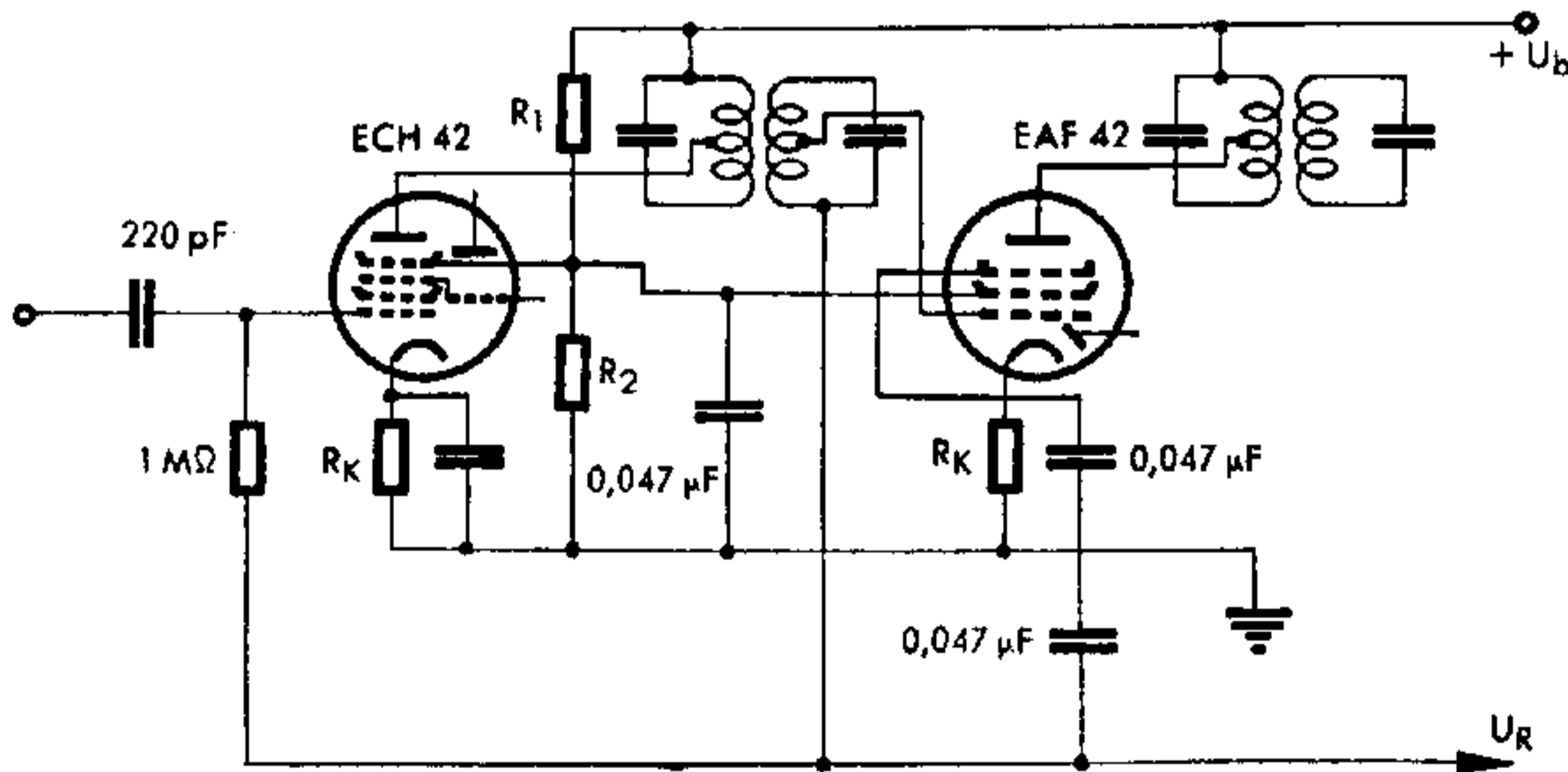

Betriebsspannung	U_b	250	V
Spannungsteiler	R_1	22	kΩ
	R_2	27	kΩ
Kathodenwiderstand	R_k	180	Ω
Gitterableitwiderstand	$R_{gT^*)}$	22	kΩ
Gitterstrom	I_{gT}	350	μA
Gittervorspannung	U_{g1}	-2	-20,5
Schirmgitterspannung	U_{g2g4}	85	135
Anodenstrom	I_a	3	—
Schirmgitterstrom	I_{g2+g4}	3	—
Mischsteilheit	S_c	750	24
Innerer Widerstand	R_i	> 1	> 5
Äquivalenter Rauschwiderstand	r_{aeq}	75	kΩ
Elektronischer Eingangswiderstand bei $f = 100$ MHz	r_e	1,8	—

*) Wenn $R_{gTg3} = 47$ k Ω gewählt wird, muß I_{gT+g3} auf 200 μ A eingestellt werden.

Betriebswerte als Phasenumkehrrohre

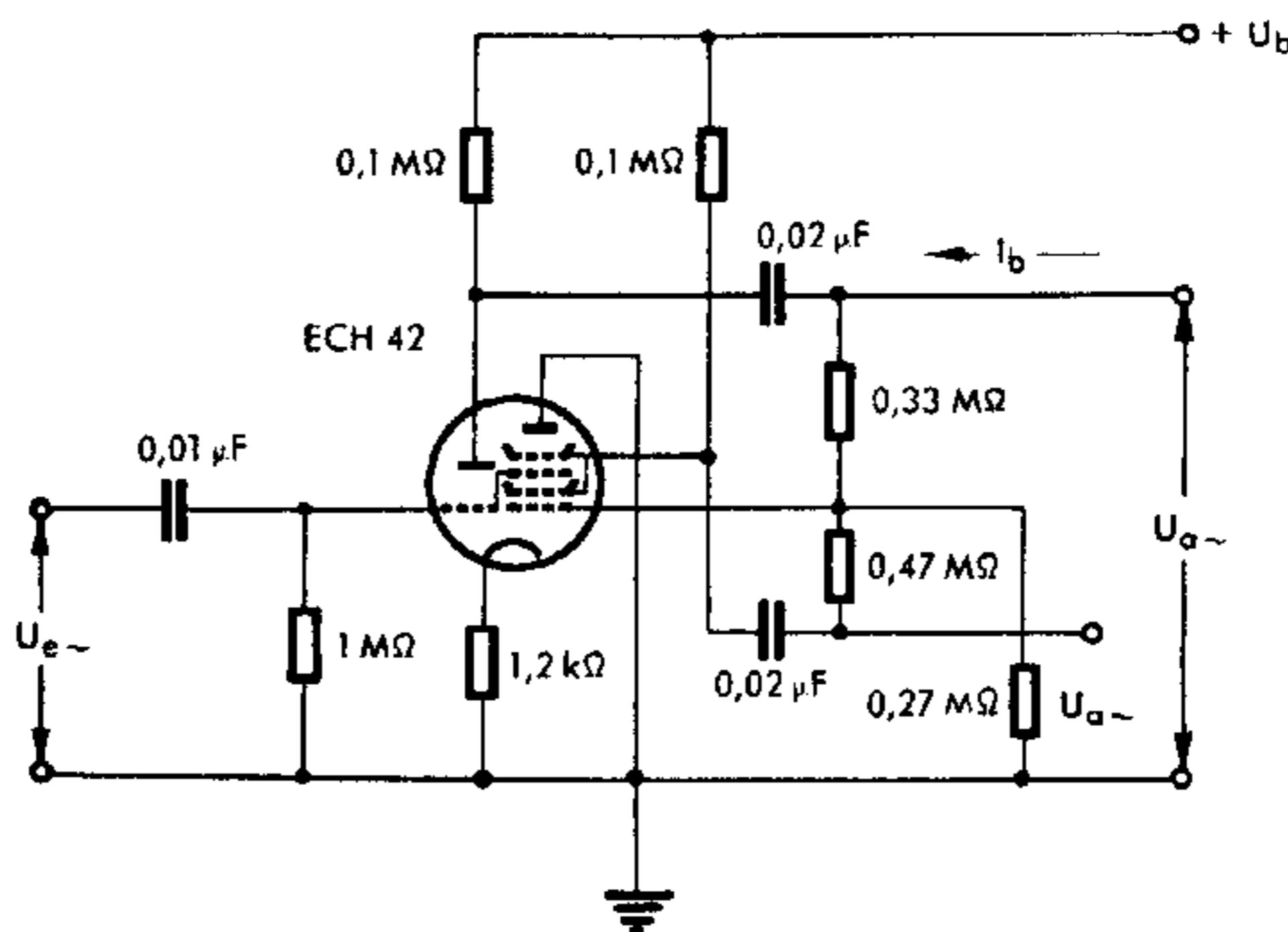

U_b (V)	I_b (mA)	$\frac{U_{a\sim}}{U_{e\sim}}$	k (%) ($U_{a\sim} = 5 V_{eff}$)	k (%) ($U_{a\sim} = 10 V_{eff}$)	k (%) ($U_{a\sim} = 15 V_{eff}$)
250	3,6	11	1,2	1,4	1,7
350	5,1	11	1,1	1,2	1,4



Grenzwerte:*Triode*

Anodenkaltspannung	U_{ao}	550	V
Anodenspannung	U_a	175	V
Anodenbelastung	N_a	0,8	W
Gitterstromeinsatzpunkt ($I_g \leq +0,3 \mu A$)	U_{ge}	-1,3	V
Kathodenstrom	I_k	6	mA
Gitterableitwiderstand	R_g	3	M Ω
Außenwiderstand zwischen Faden und Kathode	R_{fk}	20	k Ω
Spannung zwischen Faden und Kathode	U_{fk}	100	V

Hexode

Anodenkaltspannung	U_{ao}	550	V
Anodenspannung	U_a	300	V
Anodenbelastung	N_a	1,5	W
Schirmgitterkaltspannung	U_{g2g4o}	550	V
Schirmgitterspannung ($I_a = 3 \text{ mA}$)	U_{g2g4}	125	V
Schirmgitterspannung ($I_a < 1 \text{ mA}$)	U_{g2g4}	300	V
Schirmgitterbelastung	N_{g2+g4}	0,3	W
Gitterstromeinsatzpunkt ($I_{g1} \leq +0,3 \mu A$)	U_{g1e}	-1,3	V
Kathodenstrom	I_k	10	mA
Gitterableitwiderstand	R_{g1}	3	M Ω
Außenwiderstand zwischen Faden und Kathode	R_{fk}	20	k Ω
Spannung zwischen Faden und Kathode	U_{fk}	100	V



Kapazitäten:
Triode

C_e	5,9	pF
C_{ga}	1,3	pF
C_a	2,4	pF

Pentode

C_e	4,0	pF
C_{g1a}	III	0,1 pF
C_a	9,2	pF
C_{g1f}	III	0,15 pF

Triode / Pentode

Gitter Triode / Gitter 1 Hexode	C_{gTg1H}	III	0,35 pF
Gitter Triode / Anode Hexode	C_{gTaH}	III	0,2 pF

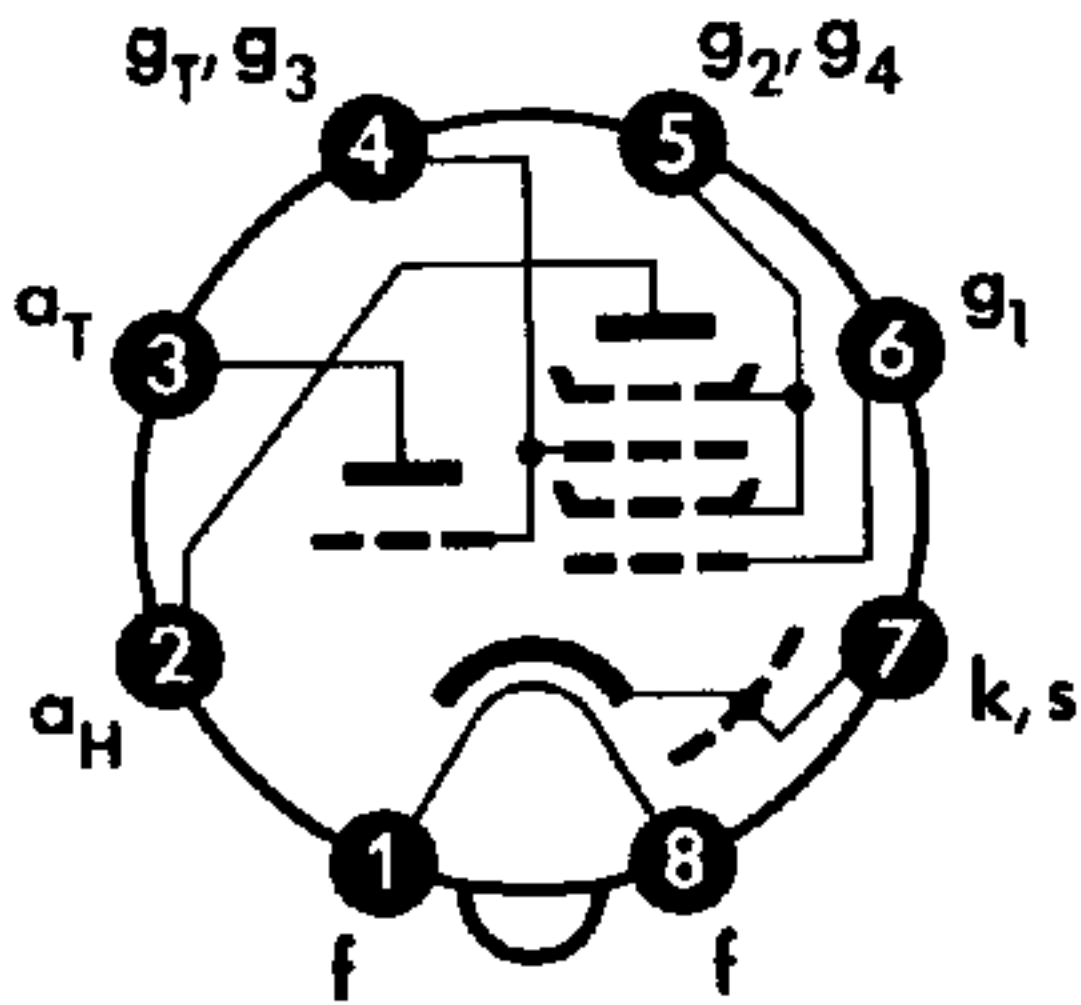
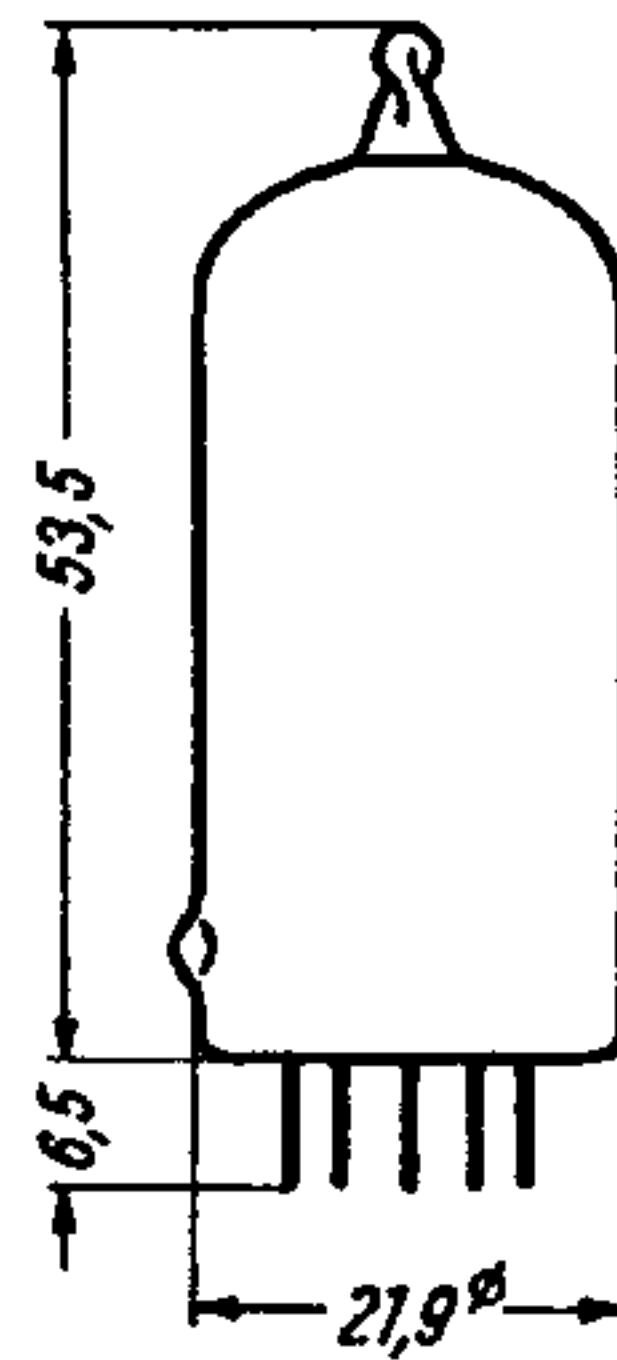
Sockelschaltbild

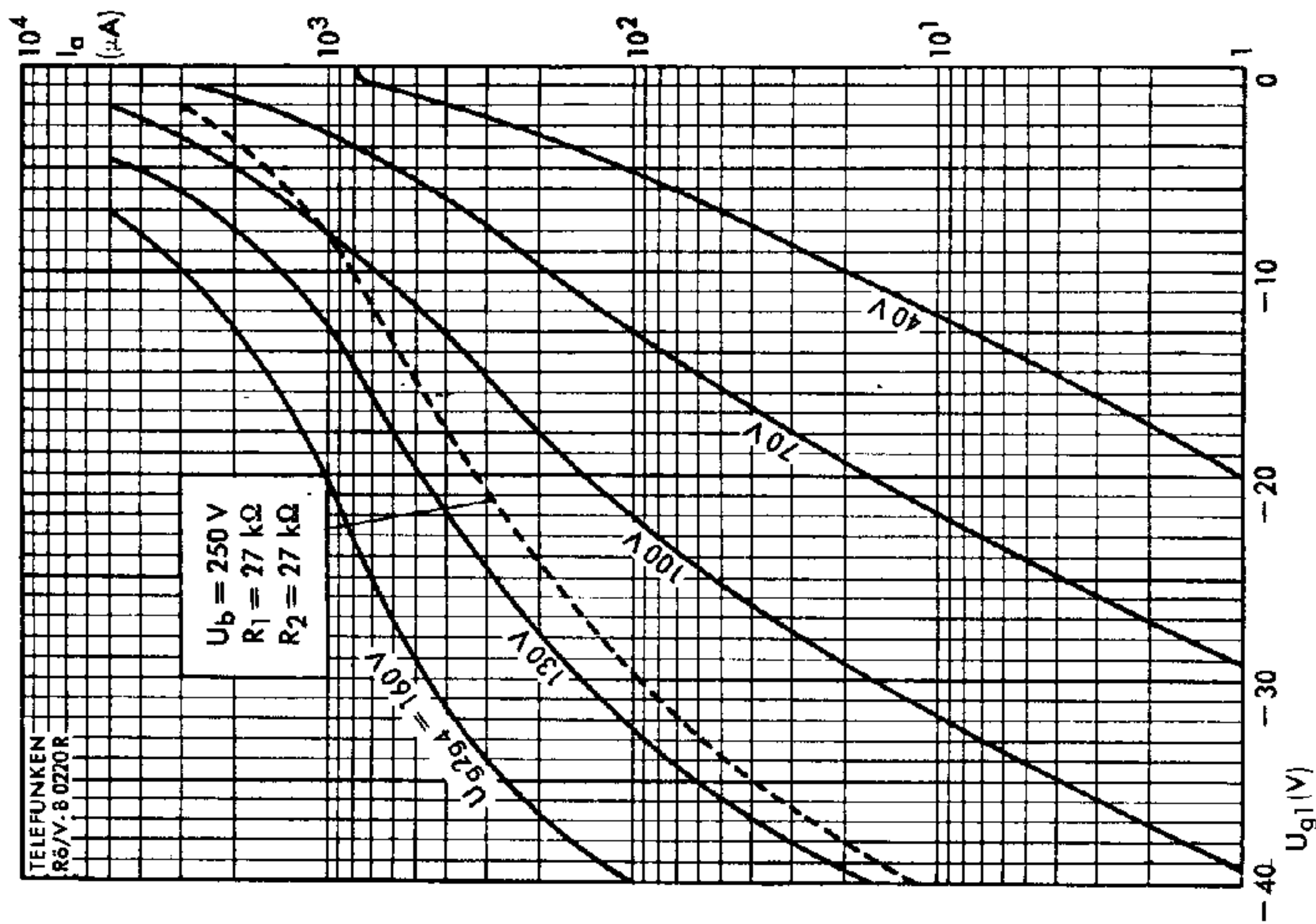
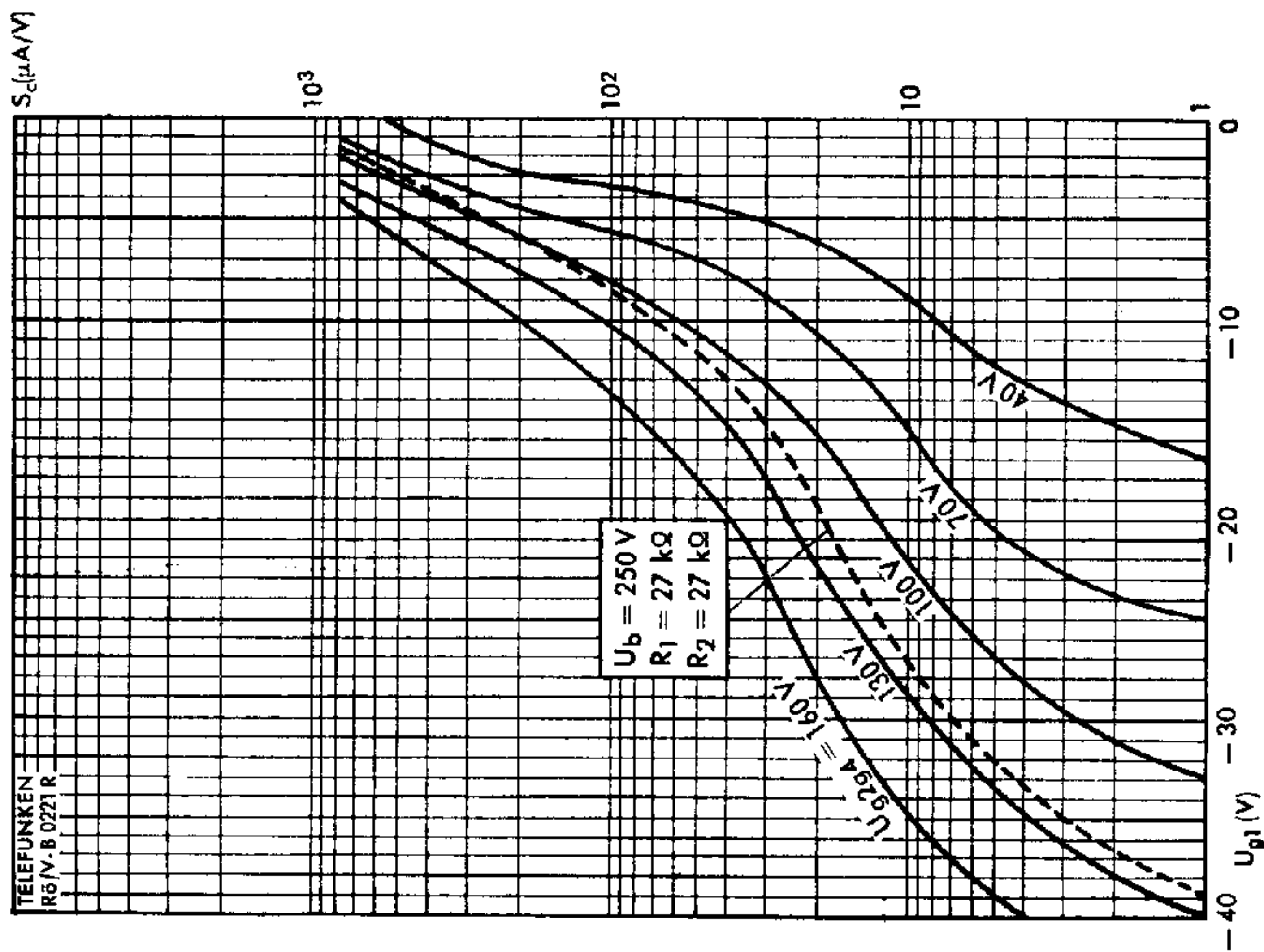
Pico 8 (Rimlock)
max. Abmessungen

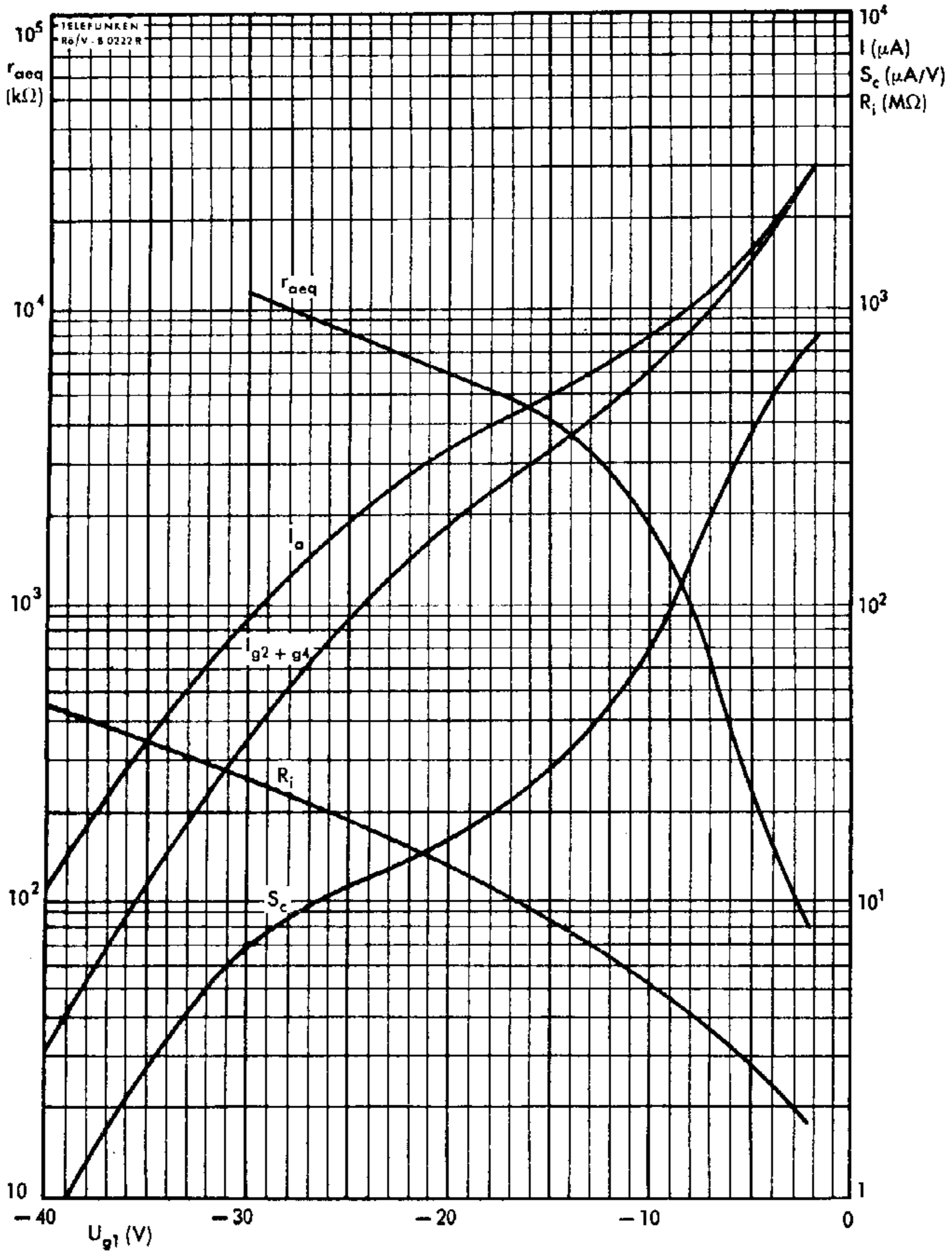
Gewicht: max. 14 g



$$I_a, I_{g2+g4}, S_c, R_i, r_{aeq} = f(U_{g1})$$

$$U_a = U_b = 250 \text{ V}$$

$$R_1 = 27 \text{ k}\Omega$$

$$R_2 = 27 \text{ k}\Omega$$

$$R_{gTg3} = 47 \text{ k}\Omega \quad 22 \text{ k}\Omega$$

oder

$$I_{gT+g3} = 200 \mu\text{A} \quad 350 \mu\text{A}$$



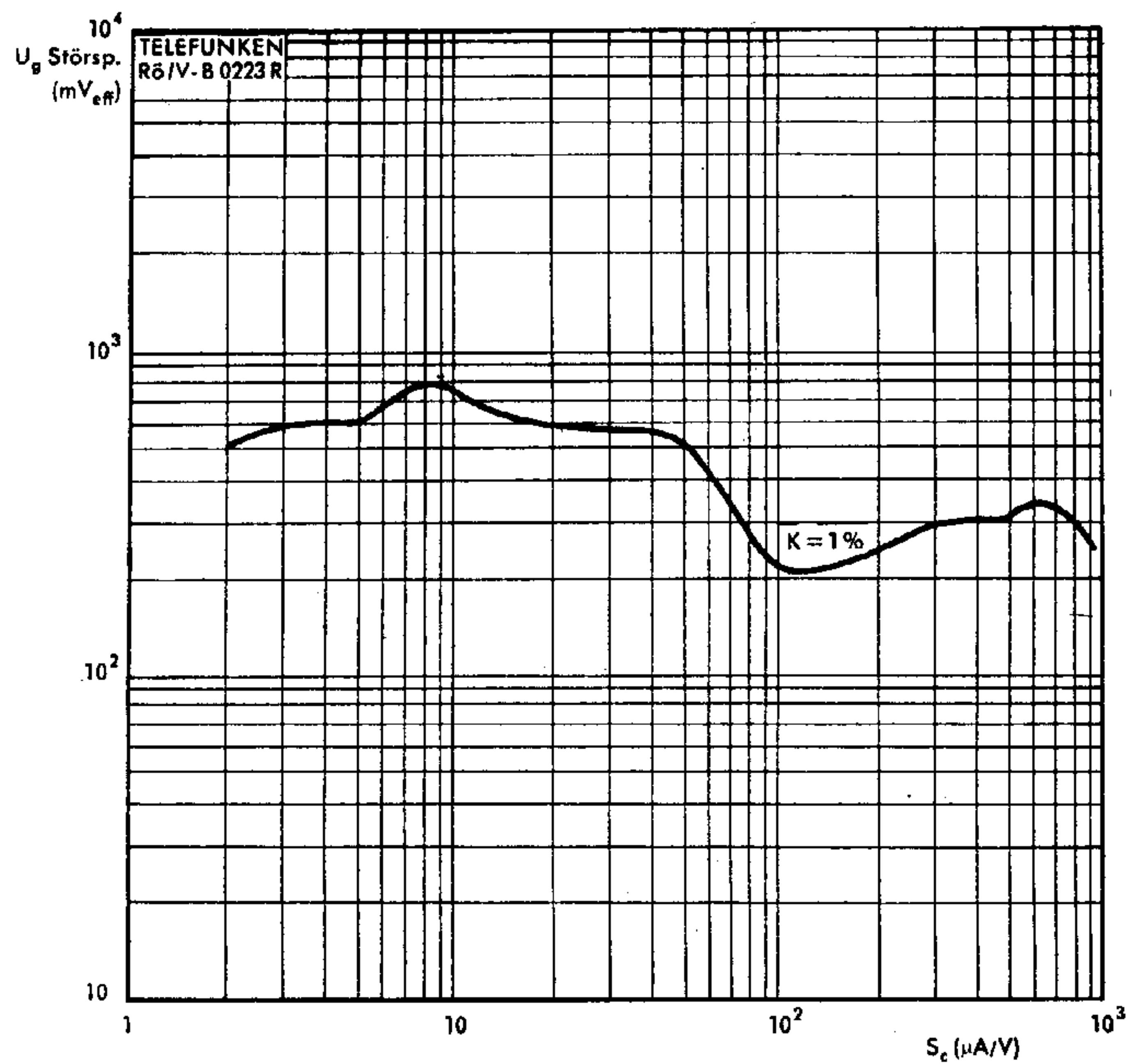

$U_b = 250 \text{ V}$
 $R_1 = 27 \text{ k}\Omega$
 $R_2 = 27 \text{ k}\Omega$
 $R_{gTg3} = 47 \text{ k}\Omega \quad 22 \text{ k}\Omega$
 oder
 $I_{gT+g3} = 200 \mu A \quad 350 \mu A$



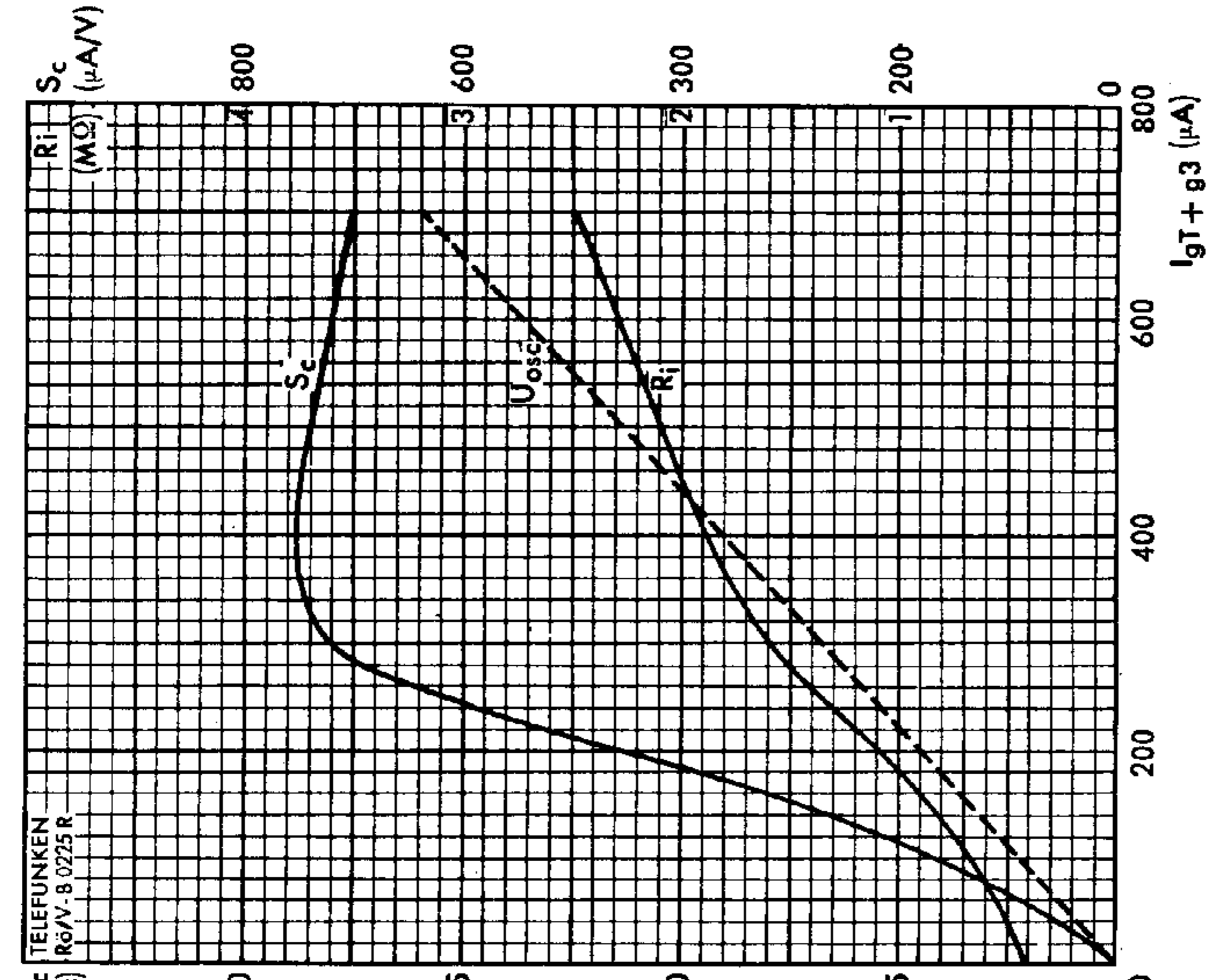

$S_c, U_{osz}, R_i = f(I_{gT} + g_3)$
 $U_a = U_b = 250 V$
 $R_1 = 27 k\Omega$
 $R_2 = 27 k\Omega$
 $R_{gTg_3} = 22 k\Omega$
 $U_{g1} = -2 V$

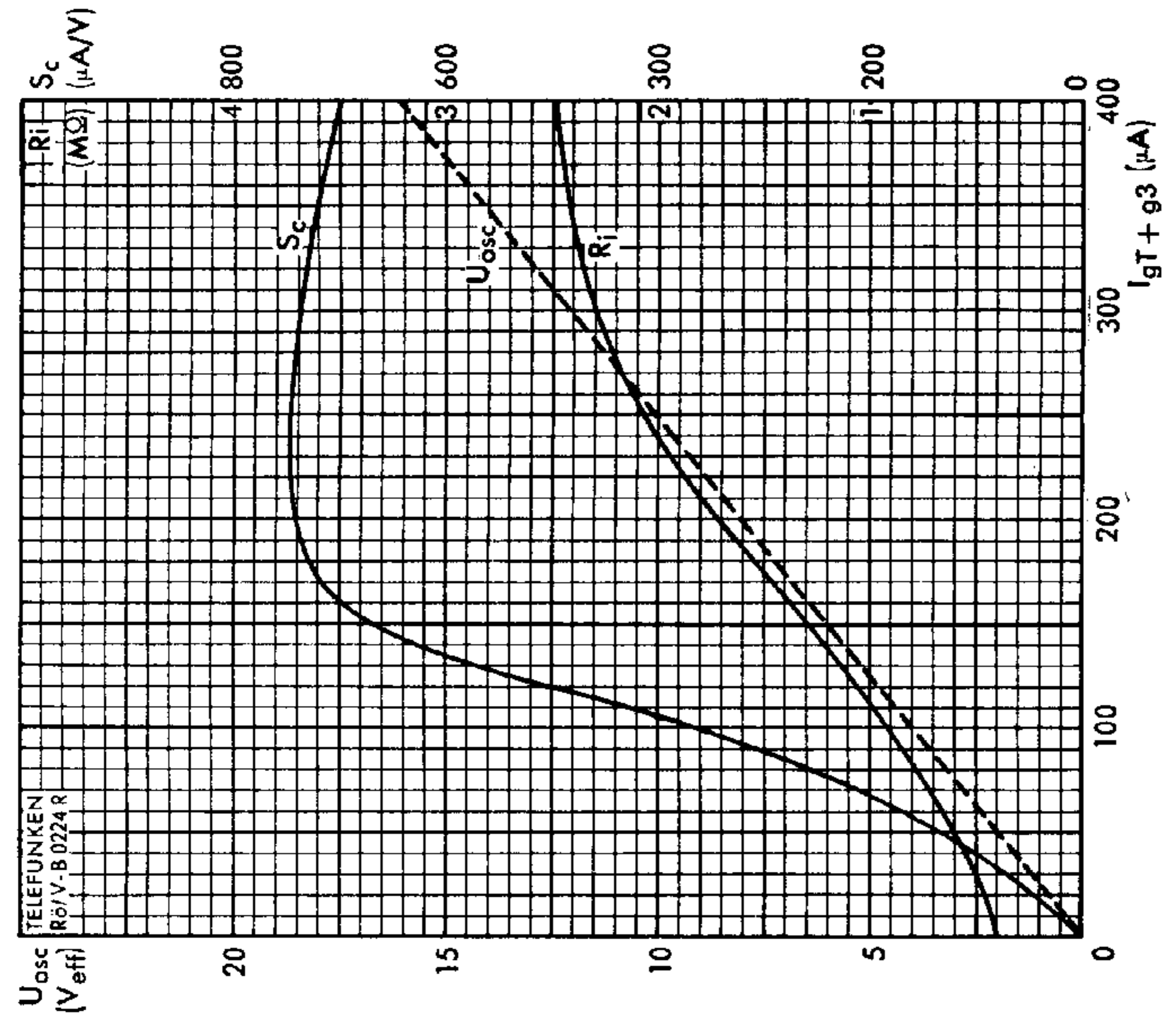

$S_c, U_{osz}, R_i = f(I_{gT} + g_3)$
 $U_a = U_b = 250 V$
 $R_1 = 27 k\Omega$
 $R_2 = 27 k\Omega$
 $R_{gTg_3} = 47 k\Omega$
 $U_{g1} = -2 V$



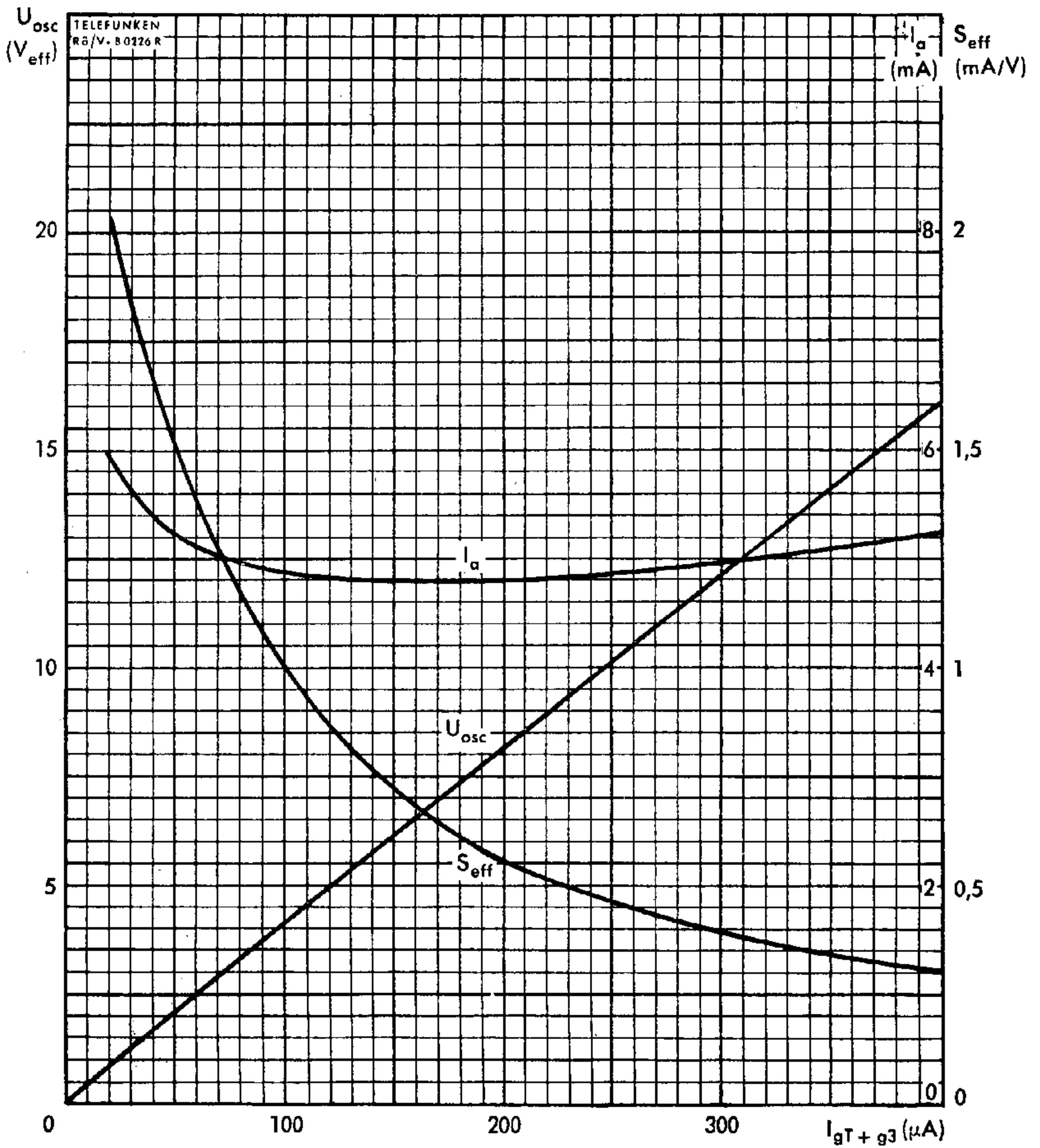

Triode als Oszillator

$$I_a, S_{eff}, U_{osz} = f(I_{gT+g3})$$

$$U_b = 250 \text{ V}$$

$$R_a = 33 \text{ k}\Omega$$

$$R_{gTg3} = 47 \text{ k}\Omega$$



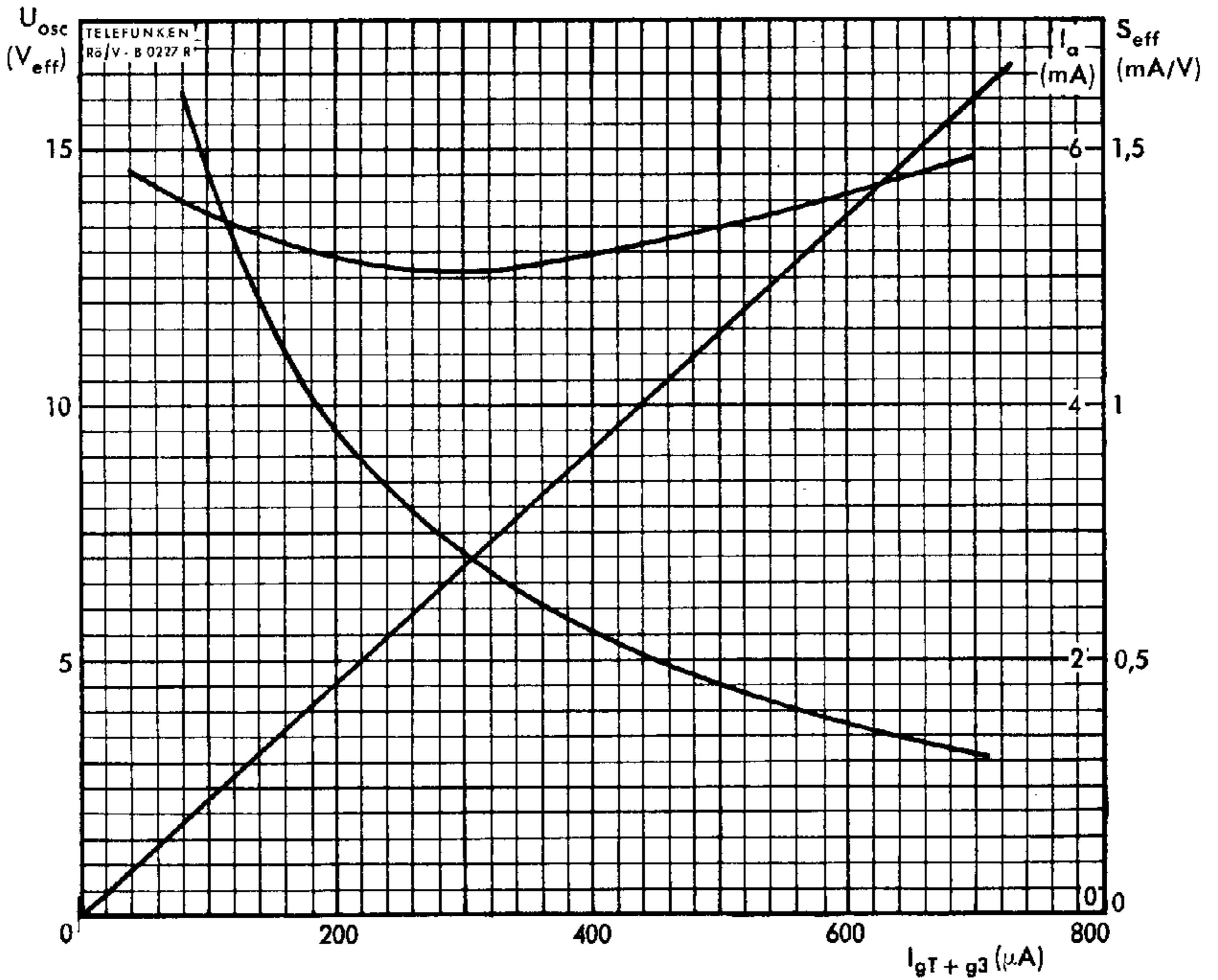

Triode als Oszillator

$$I_a, S_{eff}, U_{osz} = f(I_{gT+g3})$$

$$U_b = 250 \text{ V}$$

$$R_a = 33 \text{ k}\Omega$$

$$R_{gTg3} = 22 \text{ k}\Omega$$



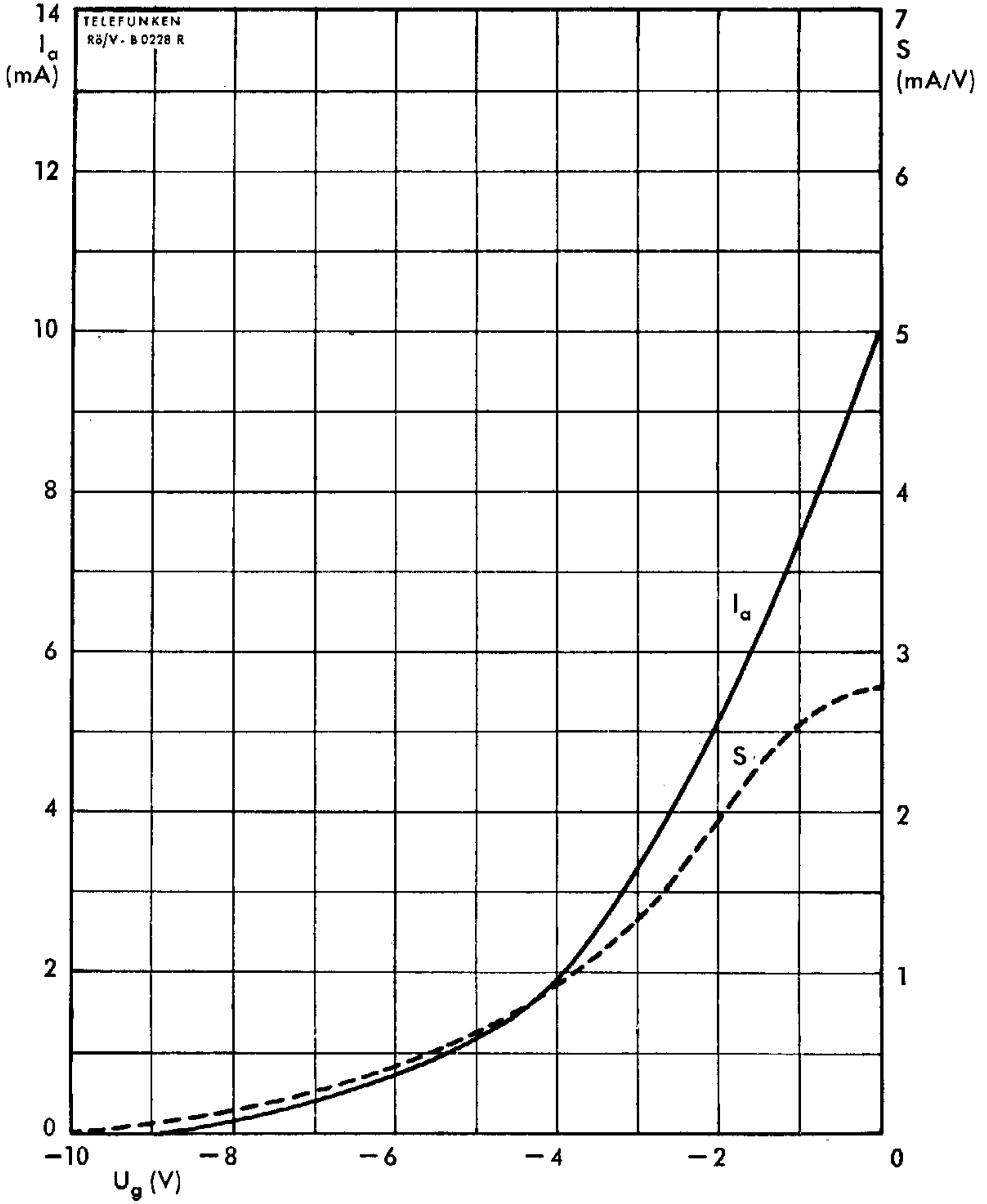

Triode
 $I_a, S = f(U_g)$
 $U_a = 100 \text{ V}$



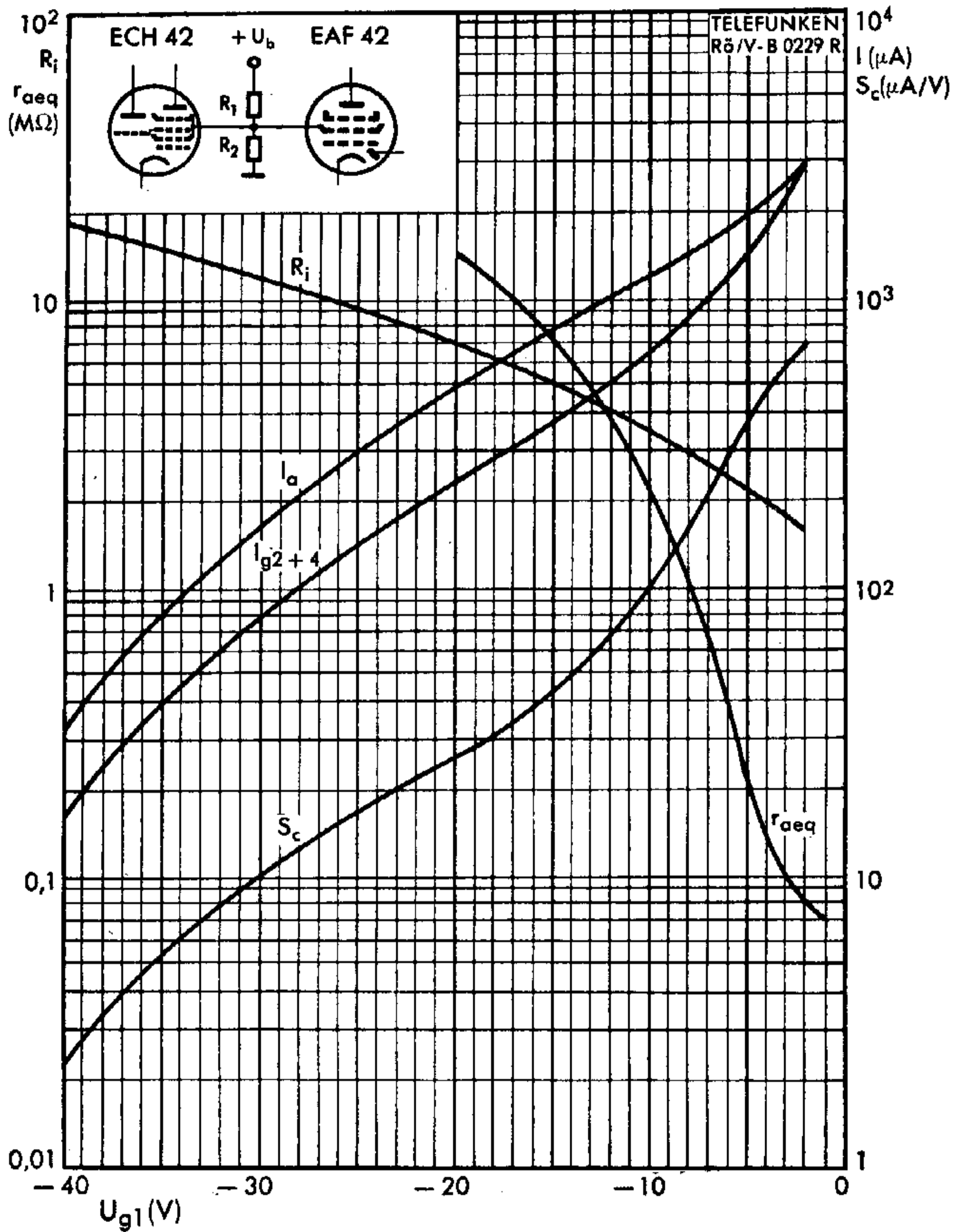

Hexode bei einem gemeinsamen Spannungsteiler mit einer EAF 42

$$I_a, I_{g2+g4}, S_c, R_i, r_{aeq} = f(U_{g1})$$

$$R_1 = 22 \text{ k}\Omega$$

$$R_2 = 27 \text{ k}\Omega$$

$$R_{gTg3} = 47 \text{ k}\Omega \quad 22 \text{ k}\Omega$$

oder

$$I_{gT+g3} = 200 \mu\text{A} \quad 350 \mu\text{A}$$



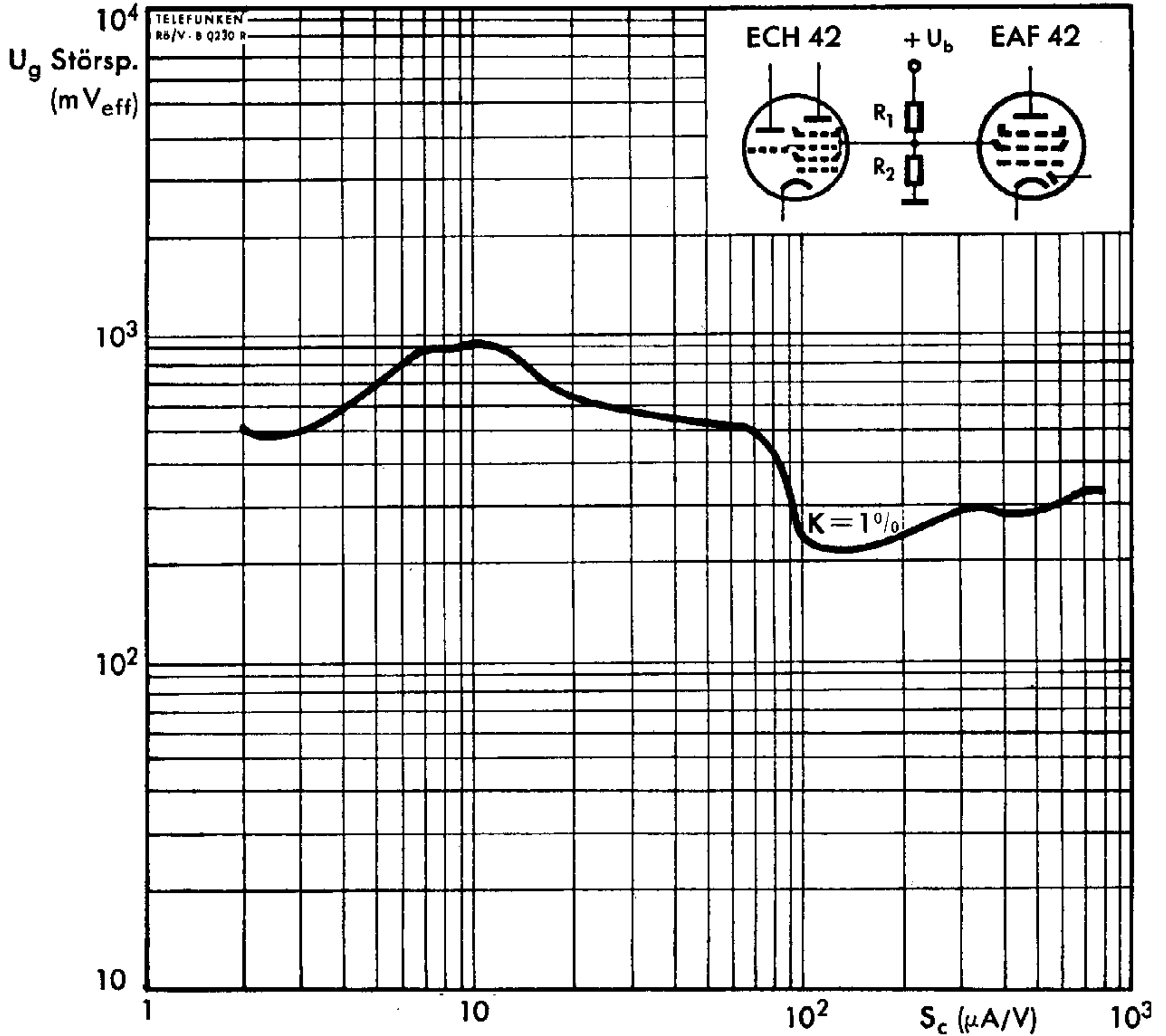

Hexode bei einem gemeinsamen Spannungsteiler mit einer EAF 42

$$U_a = U_b = 250 \text{ V}$$

$$R_1 = 22 \text{ k}\Omega$$

$$R_2 = 27 \text{ k}\Omega$$

$$R_{gTg3} = 47 \text{ k}\Omega \quad 22 \text{ k}\Omega$$

oder

$$I_{gT+g3} = 200 \text{ }\mu\text{A} \quad 350 \text{ }\mu\text{A}$$

